



International size reference: 1/10D

ELECTRICAL CHARACTERISTICS

(typical values for cells stored for one year or less, at 25°C)

Nominal capacity	1.0Ah
(At 1.0 mA, +25°C, 2.0V cut off. The capacity restored by the cell varies according to current drain, temperature and cut off voltage.)	
Nominal voltage	3.6V
Maximum recommended continuous current	10mA
(To get 50% of the nominal capacity at +25°C with 2.0V cut off. Higher currents possible, consult EVE.)	
Maximum pulse current capability	50mA
Rated 1 sec. pulse capability (to 3V)	20mA
Pulse capability varies according to pulse characteristics (frequency and duration), temperature, cell history (storage conditions prior to usage) and the application's acceptable minimum voltage.	
Storage (recommended)	30°C max
(for more severe condition consult EVE)	
Operating temperature range	-60°C / +85°C
(Operation at temperature different from ambient may lead to reduced capacity and lower voltage plateau readings.)	
Typical weight	19g

ER32L65

Lithium-thionyl Chloride
(Li-SOCl₂) Battery

KEY FEATURES

- ✓ High and stable operating voltage
- ✓ High minimum voltage during pulsing
- ✓ Low self discharge rate (less than 1% after 1 year of storage at +25°C)
- ✓ Stainless steel container
- ✓ Hermetic glass-to-metal sealing
- ✓ Non-flammable electrolyte
- ✓ Non-restricted for transport
- ✓ Compliant with IEC 86-4 safety standard and EN 50020 intrinsic safety
- UL Underwriters Laboratories (UL) Component Recognition (File Number MH28717)

MAIN APPLICATIONS

- ✓ Utility metering
- ✓ Alarms and security devices
- ✓ Memory back-up
- ✓ Tracking systems
- ✓ Automotive electronics
- ✓ Professional electronics ... etc.

WARNING:

Fire, explosion and severe burn hazard. Do not recharge, crush, disassemble, heat above 100°C, incinerate, or expose contents to water.

Note: Any representations in this data sheet concerning performance are for informational purpose only and are not construed as warranties, either expressed or implied, of future performance.

ER32L65

1. DISCHARGE CHARACTERISTICS@+25°C

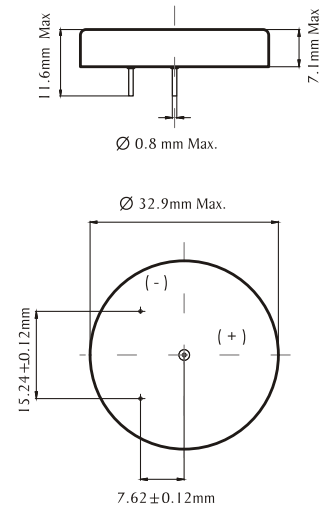
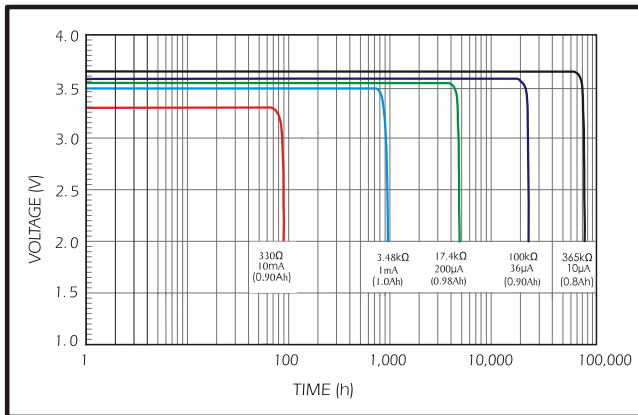

2. VOLTAGE VS. TEMPERATURE

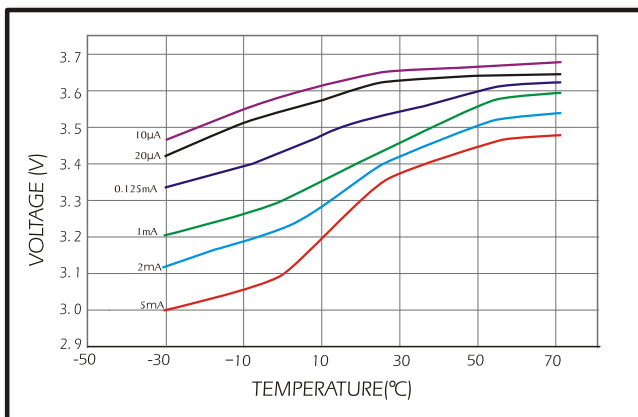

AVAILABLE TERMINATIONS

Suffix-IP Tinned Nickel Pins

3. CAPACITY VS. CURRENT

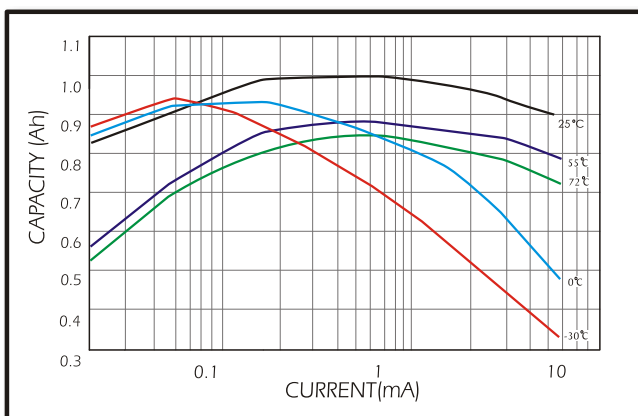

4. STORAGE CHARACTERISTICS

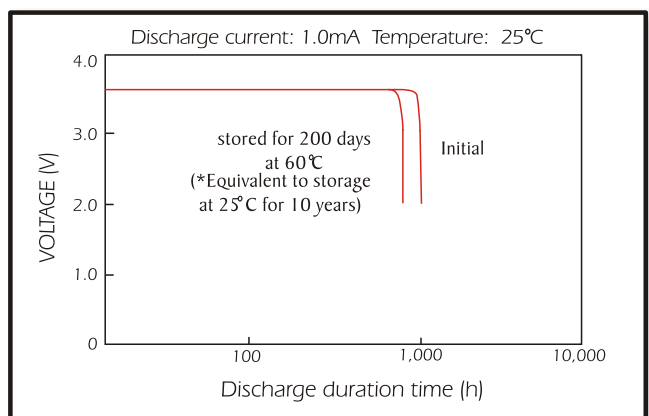

EVE ENERGY CO., LTD.

Address.: EVE Industrial Park, XiKeng Industrial zone, Huihuan Town, Huizhou, Guangdong, China
 Operator: (86-752)260 6966 Fax: (86-752)260 6033

<http://www.evebattery.com> Email: sales@evebattery.com

Latest version can be downloaded from the EVE website

May 2010